



Hardware Manual

VDH-DXC836

2016 OCT V1.0

Contents

A.	CAUTION.....	1
B.	Introduction.....	2
	1. Product Overview.....	2
	2. Main functions.....	2
C.	Unpacking.....	3
	1. Accessories.....	3
	2. Unpacking.....	3
D.	Installation.....	3
E.	Product appearance.....	4
	1. Front Panel.....	4
	2. Rear Panel.....	6
	3. Installation Illustration.....	6
	Video input.....	7
	Connections for video outputs.....	7
	Audio Inputs.....	8
	Audio Output.....	8
	AlarmIn/AlarmOut connections.....	8
	RS-485 connection.....	9
F.	Q & A and Maintenance.....	10
	1. Q & A.....	10
	2. Maintenance.....	14
G.	Appendix : Specifications.....	15
	1. 16CH DVR.....	15

A. CAUTION

To our dear customer!

Thank you for using our products. If you encounter any problems when using, please do not hesitate to contact our resellers. We will provide excellent services to you via our resellers.

The software/hardware improvements of this series are subject to change without notice to you in advance. Before using, please read this user manual carefully to ensure that you can use the device correctly and safely.

Caution for this DVR series

- After installation, never put anything heavy over this device. Owing to the use of the harddrive(s) insides this device, check the cooling fan periodically to see if it is in good condition. Never use this device when the cooling function is out of order!
- Do not allow any solid object or liquid fall into or penetrate into the device.
- Use cleaning tools (brushes) regularly to clean circuit boards, connectors, fans, chassis, etc. Before cleaning, turn off the power and unplug the power.
- Do not attempt to disassemble the equipment, repair, or replace parts. In case the machine does not work properly, please contact the resellers or manufacturers. In the shortest time, we will solve the problems you have during using.
- When not using the remote control for a long time, take out the inside battery To prevent the control from the damage coming from battery leakage!
- If this equipment connects to outdoor cameras or other external alarm devices, ground this equipment to prevent it from electrical surges.
- This DVR supports remote video monitoring via Internet. Free or non-free domain names provided by ISPs are needed for the monitoring functions. Free domain names may sometimes have problems and nothing to do with DVR. Non-free domain names have less problems. Choose the domain names carefully before using the networking function.

Operating environment

- Keep and use this device at places where temperature ranges 0°C~40°C. Avoid direct sunlight or near heat sources.
- Do not install this equipment in a humid environment
- Do not expose this equipment in smoky, dusty environments;
- Avoid strong collision, do not drop the machine
- Keep the installation level, install in a stable place, avoid the product falling;
- Do not block any ventilation openings. And ensure well ventilation around the machine
- Please use this equipment within rated input and output current/voltage range.
- This device is for long-time use. For safety, do not have flammable items placed next to the device.

B. Introduction

1. Product Overview

This equipment is an excellent digital surveillance product designed specifically for the security use. Using embedded LINUX operating system, it makes the system more stable. Using standard H.264 video compression and G.711A audio compression technology achieves audio and video functions such as high-quality, low bit rate and single-frame playback. Using TCP / IP and other network technologies, it provides strong network data transmission capacity and remote control capabilities.

This equipment can be used individually or be connected to form a powerful security monitoring network. Using professional network video surveillance software platform, be fully experienced the powerful networking and remote monitoring capabilities.

This equipment can be used for security in banks, telecommunications, power stations, justice, transport, intelligence communities, factories, warehouses, resources, water conservancy facilities and other categories.

2. Main functions

- Pentaplex Operation: which can Record / Playback / Remote Connection / mobile phone watch / video backup
- Support 4 fixed internal Hard Drives, single hard drive can be up to 4TB.
- Support RAID recording to protect important video data.
- Support HD output (1920x1080)
- Support real-time recording and playback
- Smart function: Motion detection area can be divided into 192(16x12) sub-areas.
- Support IE/Chrome/Firefox/Safari. On-line recording/playback and user management are available.
- Support HTTP, DHCP, DDNS, NTP, SMTP, FTP, DNS, UPNP, PPPoE, IP rights, IP search and other Internet services
- Support iPhone, Android, including live video monitoring, playback.
- Support CMS(Central Management System)
- Back-up to USB storage at the same time when recording
- Support DVD / RW & portable HardDrive rack
- Support analog/digital modes to record analog/digital signals at the same time

C. Unpacking

1. Accessories

- ★ Power cable and adaptor AC100-240V/DC12V 5A x 1PCS
- ★ HDD screws x 16pcs
- ★ Operation CD x 1pcs
- ★ Mouse x 1 pcs

2. Unpacking

When you receive the product, check first whether the packing of the equipment has obvious damage. The protective material used for the package during transport can cope with most of the accidental impact

Then, take out the device, remove the protective film of the digital video recorder and check if there is any visible damage;

Finally, open the case, check the front panel data cable, power cord, power supply fan and motherboard to see if they are connected firmly.

■ Front/Rare panels

The key functions of the front panel and the interfaces of the rear panel are described in detail in the manual.

Please carefully check the plate or foil on the rear panel of the product to see if it is the model you ordered.

■ Inside check

In addition to checking for visible signs of damage, be careful to check the connections between the front panel data cable, power cord and motherboard.

D. Installation







Steps and cautions:

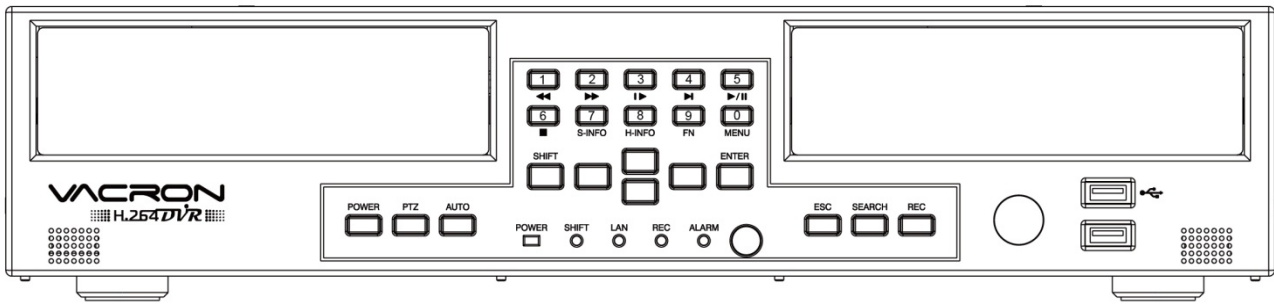









- 1 ∙ Room temperature below 35°C
- 2 ∙ Reserve space for air circulation around 15 cm (6 inches)
- 3 ∙ Chassis installation starts from bottom to up
- 4 ∙ With multiple components in the chassis, take precautions to avoid overloading to the power outlet.

E. Product appearance

1. Front Panel



	MENU	Under the live viewing mode, press MENU to enter the main menu.
	Shift pressed KEY_0/+10	Input "0" in text input mode; Display channel 10 in display mode. Or press over 2 seconds, then press '1' - '6' to display 11-16 channel.
	Fast Rewind	Under the playback mode, there are 4 choices for the speed. Choose your choice to fast rewind.
	Shift pressed KEY_1	Input "1" in text input mode; Display channel 1 in display mode.
	Fast Forward	Under the playback mode, there are 4 choices for the speed. Choose your choice to fast forward.
	Shift pressed KEY_2	Input "2" in text input mode; Display channel 2 in display mode.
	Slow Forward	Under the playback mode, there are 4 choices for the speed. Choose your choice to slow forward.
	Shift pressed KEY_3	Input "3" in text input mode; Display channel 3 in display mode.
	Step Forward	To playback frame by frame when paused in playback mode. (Press Pause before operation)
	Shift pressed KEY_4	Input "4" in text input mode; Display channel 4 in display mode.
	Play Pause	Under the live viewing mode, press the Play button to enter the playback mode and backup mode. Under the playback mode, press to play back. When playing, press to pause playback.
	Shift pressed KEY_5	Input "5" in text input mode; Display channel 5 in display mode.
	STOP	To stop the playback under the playback mode.
	Shift pressed KEY_6	Input "6" in text input mode; Display channel 6 in display mode.

S-INFO	System Information	Anytime, press this button to show version information.
	Shift pressed KEY_7	Input "7" in text input mode; Display channel 7 in display mode.
H-INFO	Hard Drive Information	Anytime, press this button to show hard drive information.
	Shift pressed KEY_8	Input "8" in text input mode; Display channel 8 in display mode.
FN	Function key	Press to enter function menu
	Shift pressed KEY_9	Input "9" in text input mode; Display channel 9 in display mode.
Shift	Shift key	Dual-function keys switch.
	UP DOWN	To move up or down of the selection setting in the UI menu. Under the live mode of Single/Quad/8/9 display, use the button to control video display.
	LEFT RIGHT	To move left or right of the selection setting in the UI menu. Under the live mode, change to Single/Quad/8/9/16 display mode.
	ENTER	Press the Enter button to confirm the setup or go into main menu in live mode.
ESC	ESC	Exit the current menu.
SEARCH	SEARCH	Access to playback & backup menu
	REC	Under the live mode, Press the REC button to enter recording menu. (menu for manual recording)
	AUTO Switching	In live mode, press to setup auto-switching or enable/disable auto-switching
PTZ	PTZ	Set up PTZ function
POWER	POWER	Press 3 seconds to achieve soft shutdown; press to wake up power-off state.
	POWER Indicator	POWER Indicator
	LAN Indicator	LAN Indicator (When users use network functions, it will be turned on.)
	SHIFT Indicator	SHIFT Indicator
	REC Indicator	DVR REC Indicator
	ALARM Indicator	ALARM Indicator (When AlarmIN, Video Loss, Video Blind or motion detection enabled and triggered, the indicator will be turned on.)

2. Rear Panel
16 ch DVR illustration

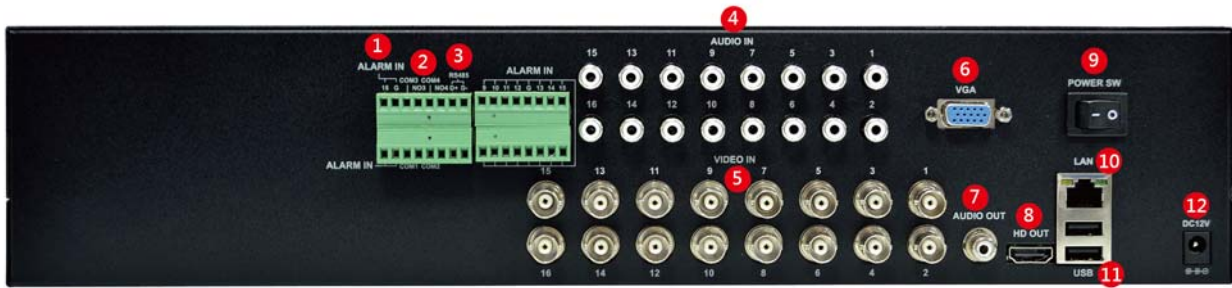

1	Alarm Input
2	Alarm Out
3	RS-485 Port
4	16 channel Video Input
5	16 channel Audio Input
6	VGA output
7	Audio Output
8	HD Digital Output
9	Power Switch
10	LAN port
11	USB Mouse Port
12	DC12V Power Input

● Alarm In/Alarm Out/RS-485

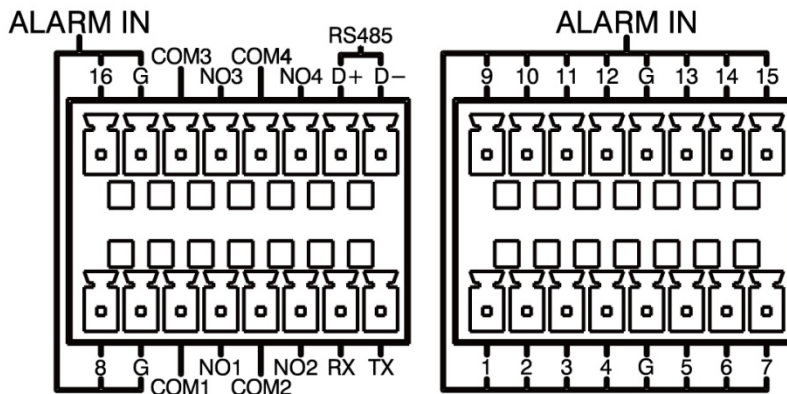

3. Installation Illustration

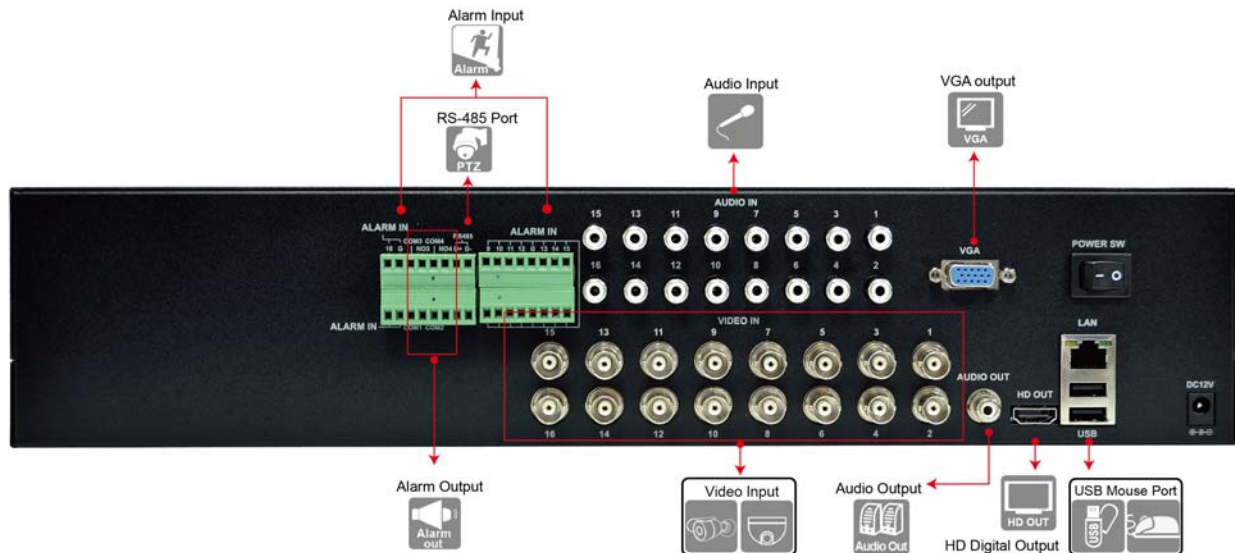

■ Video input

Input interface is BNC type; input signal is PAL/NTSC BNC (1.0VP-P · 75Ω)
The Video signal should comply with national standards, a higher signal to noise ratio, low distortion, low-interference; clear images, no deformation, nature color and appropriate brightness.

◆ Make sure stable and reliable signals from cameras

Cameras should be installed in a suitable position to avoid backlighting, low-light environment, or adopts the better BLC, low-light cameras.

Cameras and digital video recorders should be common ground, stably and reliably, in order to ensure the normal operation of the cameras.

◆ Make sure the transmission cables are stable and reliable

Adopt high-quality, well-shielded coaxial cables, and choose the right model based on the transmission distance. If the distance is too far, use shielded twisted pair, video compensation equipment, optical transmission and other ways to ensure signal quality based on the specific circumstances.

Video cable should avoid strong electromagnetic interference with other devices and circuits, in particular, should avoid the current of high voltage.

◆ Make sure the connectors well-connected:

Cables and shielded cable should be well-connected firmly to avoid false, joint welding or oxidation.

■ Connections for video outputs

The video outputs include PAL/NTSC BNC(1.0VP-P · 75Ω), VGA and HD OUT interfaces.

Pay attention to the following when you select a PC display instead of a monitor.

1. Do not remain switched on for a long time to extend the life of the equipment;
2. Regular degaussing will help to maintain the normal operation of the monitor.
3. Keep away from equipment with strong electromagnetic interference.

Using TV as video output device is an unreliable alternative. It is also required to minimize the time of use and strictly control the power, the interference caused by neighboring devices. Leakage risks of low quality TVs may result in damage to other equipments.

■ **Audio Inputs**

Voice input impedance is high, so the microphone must be a microphone connected to the power supply.

Like video input, voice transmission cables should avoid interference, fake, poor contact, and special attention to prevent the current of the high-voltage.

■ **Audio Output**

The audio output parameters of DVR are generally greater than 200mv 1K Ω (BNC), you can directly connect to the low impedance headphones, powered speakers or other sound devices through a power amplifier.

When the external speakers and microphones can not achieve spatial segregation, it is prone to the phenomenon of whistling.

You may adopt the following actions,

1. Using better directional microphones
2. Adjust the speaker volume to make it lower than the value of the generated howling.
3. Using sound-absorbing materials for decoration to reduce sound reflections and improve the acoustic environment;
4. Adjusting the layout of the microphone and speakers can reduce the whistling.

■ **AlarmIn/AlarmOut connections**

Pay attention to the following before installation.

1. AlarmIn
 - (a) Alarm input is grounding alarm input
 - (b) The alarm input signals require voltage signals to the ground
 - (c) When the alarm device is shared with two DVRs or connected to a DVR and other devices, it should be isolated by relays.
2. Alarm OUT

The alarm output of the DVR can not be connected with high-power load (no more than 1A). In the output circuit, be careful about the excessive current that may cause damage to the relay. When using high-power load, extra relays are needed.

- RS-485 connection
 1. Connect RS-485 cable of the speed dome to the RS-485 interface of DVR, pay attention to the positive and negative signals.
 2. Connect the video output cable of the speed dome to the DVR video input

F. Q & A and Maintenance

1. Q & A

Q 1. After power on, DVR doesn't work.

A: The possible causes:

1. Wrong power input
2. bad connection of power cable
3. Power error
4. Firmware update error
5. Disk error or cable problem
6. Front panel error
7. Main PCB board error

Q 2. After power-on, DVR will restart after several minutes or the screen freezes.

A: The possible causes:

1. Unstable or low input voltage
2. The hard drive has bad sectors or cable error
3. Low adaptor power
4. Front video signal not stable
5. High temperature, too much dust and the machine runs in a bad condition
6. DVR hardware error

Q 3. HDD not found after power-on

A : The possible causes:

1. No power for the Hard Drive
2. Hard Drive cable error
3. Hard Disk error
4. Main board SATA slot error

Q 4. No output: Single, multiple or all channels

A : The possible causes:

1. Wrong firmware: Update to the right firmware
2. Brightness set to 0: set it to the default value
3. No signal input or signal too weak
4. Mask used
5. DVR hardware error

Q 5. Live video problems: Such as bad colors, brightness error, image blink...

A : The possible causes:

1. When using BNC as output, wrong NTSC/PAL matching will result in

B/W image.

2. Impedance mismatch between digital video recorder and monitor.
3. Video transmission distance is too far or video transmission line attenuation is too much
4. Wrong settings of colors, brightness in the DVR

Q 6.No recorded file in local side

A : The possible causes:

1. Wrong data cable or jumper error in the harddisk
2. Hard Disk error
3. Upgraded firmware can not recognize the existing file system
4. Desired files are overwritten
5. Recording not enabled

Q 7.Bad image when playback

A : The possible causes:

1. Low recording quality
2. Once data error when reading or small bit-rate or fuzzy when playback, please reboot machine.
3. Wrong data cable or jumper error in the harddisk
4. Hard Disk error
5. DVR hardware error

Q 8.No audio sound

A : The possible causes:

1. Not powered-microphone
2. Not powered-speaker
3. Audio cable error
4. DVR hardware error

Q 9.Live video with audio, but no sound when playback

A : The possible causes:

1. Wrong setting: audio not enabled
2. No video to the paired channels; when the screen is blue, playback will be choppy.

Q 10. Wrong time

A : The possible causes:

1. Wrong setting
2. Bad battery connection or low voltage
3. Bad frequency oscillator

Q 11. DVR can not control PTZ

A : The possible causes:

1. PTZ error
2. Wrong settings, cabling and installation for the PTZ
3. Wrong wiring
4. Wrong PTZ settings in the DVR side
5. Protocols mismatch between PTZ and DVR
6. Mismatch between PTZ decoder and DVR ID address
7. When connected to several decoders, the farthest AB line of PTZ decoder must add a 120 ohm resistor to eliminate reflection and impedance matching, otherwise it will make PTZ unstable.
8. Distance beyond limitation

Q 12. Motion detection not function

A : The possible causes:

1. Wrong schedule settings
2. Wrong area settings
3. Low sensitivity
4. Hardware limitation for different version

Q 13. Fail to login by using client software or Web browsers

A : The possible causes:

1. Operating system is Win98 or Win Me and the client software can not be installed or displayed normally; Upgrade the operating system to Win2000sp4 or above, or use lower versions of the client software.
2. ActiveX control blocked; install the ActiveX control in the attached CD.
3. DX8.1 or above not installed; upgrade the display driver.
4. Networking error
5. Wrong Networking settings
6. Wrong user/password
7. Wrong client software for the DVR firmware

Q 14. Mosaic or no video when Network preview and file playback

A : The possible causes:

1. Network traffic jam
2. Bandwidth limitation in the DVR side
3. Group mode is used in the DVR networking setting. More mosaics in group mode, not recommended.
4. Masks or channel protection in DVR side
5. No rights for the user account
6. Bad DVR output

Q 15. Networking not stable

A : The possible causes:

1. Networking not stable
2. IP conflict
3. MAC conflict
4. LAN card error (PC/DVR)

Q 16. USB backup error

A : The possible causes:

1. CPU too busy to back up the data! Stop recording then backup!
2. Device not compatible
3. Backup device error

Q 17. DVR can not be controlled by the keyboard

A : The possible causes:

1. DVR has wrong port setting
2. Wrong address
3. Low power for use; each adaptor need to be powered.
4. Transmission distance is too far

Q 18. Alarms can not be stopped

A : The possible causes:

1. Wrong alarm settings
2. AlarmOut turned on manually
3. Input equipment error or wrong connections.
4. Wrong firmware problem; Upgrade firmware to fix it.

Q 19. Alarms do not work

A : The possible causes:

1. Wrong alarm setting
2. Wrong alarm wiring
3. Wrong AlarmIn signal
4. One alarm equipment involves into two loops.

Q 20. The remote controller can not work

A : The possible causes:

1. Wrong control address
2. Long distance or poor angle
3. Battery run out
4. Controller or DVR front panel is out of order

Q 21. Short recording time

A : The possible causes:

1. Bigger data rate from poor camera quality, dirty lens, backlight installation, bad aperture adjustment.
2. Small HDD storage
3. HDD damage

Q 22. Download files can not be played back.

A : The possible causes:

1. No player
2. No graphic accelerator with DX8.1 or above
3. Save as AVI files and play with MEDIA PLAYER

Q 23. Forget the administrative password or Internet password

A : The possible solution:

1. Please contact local customer service staff or call the customer service phone headquarters, we will guides you how to solve by the machine type and version of the program.

2. Maintenance

- Damped dust on the PCB board will cause a short circuit and will do something wrong to the DVR or damage it. For long-term stability of the DVR, regularly brush the circuit boards, connectors, fans and chassis to remove dust.
- Please ensure the project is well-grounded, so images, audio signal will not be disturbed. At the same time, we can protect the DVR from static or inductive voltage damage.
- Do not remove audio/video cables and RS-484 when the DVR is powered on, or they will be damaged.
- Do not use the TV interface in the DVR video output (VOUT), or the DVR output circuit will be damaged easily.
- Do not turn off the power switch directly to shut down the DVR. Use the menu shutdown or OFF button on the front panel (press more than three seconds) to turn off the power automatically to avoid hard Drive crash.
- Keep the DVR away from heats and hot places.
- Keep the DVR chassis well-ventilated for better heat dissipation.
- Have regular checks and system maintenance ◦

G. Appendix : Specifications

1. 16CH DVR

Video	Input	BNC	16CH Input / BNC(1Vp-p 75Ω)
	Output	VGA Resolution	Yes
		High Definition(HD)	Yes
Audio	Input		16CH Input (W/ 2-Way Audio)
	Output		1CH Output
	Audio Compression		G.711A
Alarm	Sensor Input		16CH Input, Normal Open/ Close
	Alarm Output		Sensor, Motion, Video Loss, 4CH Output
Display	Frame		1080P
	Digital Zoom		Area selected by mouse dragging
	Auto Sequence Duration		5-120 sec
Recording	Video Compression		H.264
	Resolution		Each Channel can individual setup for 1080P/720P/960H/D1/CIF
	Frame	NTSC	16CH 1080P @12FPS/CH(NTSC)
		PAL	16CH 1080P @12FPS/CH (PAL)
	Recoding Quality Grade		Lowest, Low, Normal, Good, High, Highest
	Recording Mode		Continuous/ Schedule/ Motion/ Alarm/ Manual
	Motion Detection		Zones: 192(16×12 grid)
	Pre-Record		1-30 sec
	Post-Recording		10 ~ 300 sec
Display Mode			Single, Quad, 8-Split, 9-Split, Sequence
Backup	File Format		AVI / use defined format
	Media Interface		USB/Network
	Player Software Automatic backup		Yes
Network	Dual Stream		1080P/720P/960H/D1/CIF
	Playback		Yes
	Communication Protocol		HTTP、DHCP、DDNS、NTP、SMTP、FTP、DNS、UPNP、PPPoE、IP Authority、IP Search
	Browser		IE
	Browser(single channel display)		Firefox、Safari
Storage	HDD	Interface	SATA

	Maximum support capacity	Maximum 4TB HDD
	Internal HDD	4pcs
	Mirror	Yes
	External USB	The port of USB storage device provides simultaneous recording
	File System	Stable and reliable self-developed file system
	S.M.A.R.T	HDD error detecting
User Interface	Menu Display	GUI interface ; VGA & HD out simultaneously
	Input Method	Front Panel / Remote Controller(Optional) / Mouse
Serial Interface	PTZ & Controller	Pelco-D / Pelco-P (RS-485)
Network	Ethernet	1*RJ-45, 10/100 Base-T
	Web Monitoring	Live, Search/Playback, Backup, PTZ, Remote Setup/Upgrade
Features	Daylight Saving Time (DST)	Yes
	Internal Buzzer	Motion 、 Alarm 、 Video Loss 、 HDD Error
	Multi Language	Yes (more than 20 languages)
	Firmware Update	USB, Network Remote Upgrade
	Network Time Protocol (NTP)	Yes
	3G Mobile Phone	iPhone, Android, Mobile App supports Live video & audio, and playback.
	Central Management Software(CMS)	Yes
	Hybrid(Digital & Analogue)	Yes
General	Operating Environment	Temperature 0~46°C, Humidity: 20~80%
	Power	DC 12V / 4.16A(AC100V~240V 50/60HZ)
	Weight	about 4.5kg (without HDD and Power Adapter)
	Dimension	419mm x 392.6mm x 97mm (W x D x H)

★Product specifications are subject to change without notice; please contact us for the latest information.



Manufacturer :

FUHO TECHNOLOGY CO., LTD.

No. 30 Lane 726 Sec. 3 Jinma Rd., Changhua City

Phone: 886-4-751- 2881 Fax: 886-4-751-6631
