

Mobile DVR for Motorcycle

Quick User Manual

2CH H.264 HD



2-Channel Mobile Video Recorder



Packaging

- Accessories
 1. DVR Host
 2. HD camera *2
 3. WiFi dongle
 4. Camera cable 2.5meter*2
 5. Power cable
- Optional Accessory:
 1. OBD
 2. SD card, 8/16/32G Class10 or above

H12AE0B04

Installation diagram

Installation on motorcycle (For example)

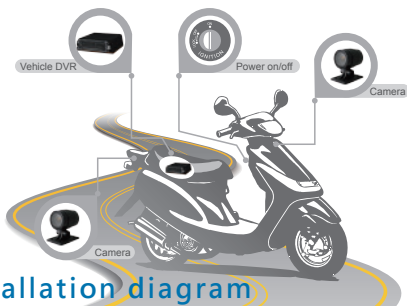

DVR installation diagram

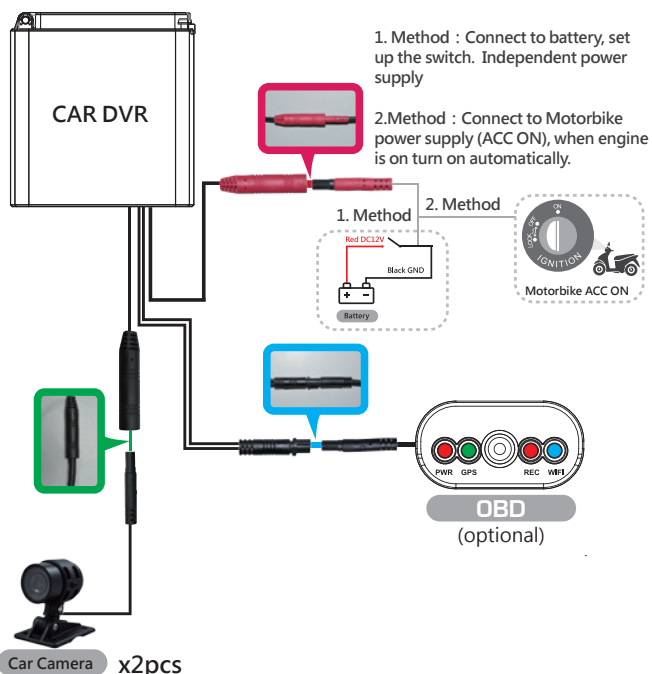

Product appearance

■ DVR Host

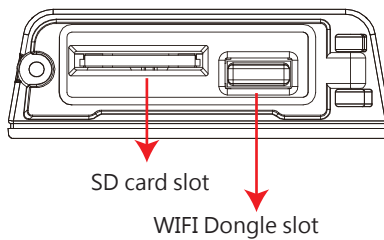

■ OBD (optional)

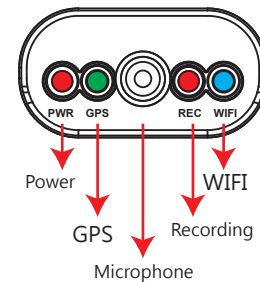

Cable Installation



- DVR Cables
 - (1) Camera 1 connector
 - (2) Camera 2 connector
 - (3) Multi-functional OBD display connector
 - (4) Power Connector

Note : Please use 720P AHD camera
- Power Cable
 - (a) (RED): Connect to positive electrode
 - (b) (Black): Connect to negative electrode

Recording & Stop Recording

- System initialization/Recording

System initializes within 30 seconds when power is on. PWR red light on when system is rebooting. System starts to recording when REC red light is flashing.
- Shut off / Stop recording

Device offer prolong 3 seconds recording after power off to ensure date is well stored, user can take out the SD card when indication is off.

Viewer

- *Notes:
- (A) To do this, the software should be installed DirectX 9.0 or above.
 - (B) Support OS: WINDOWS 7,8,10, does not support MAC OS
 - (C) The recommended hardware requirements: i3 above grade 2.7GHZ, RAM: 4G or more, more preferably independent display card



WiFi Connection

VACRON MOTO for IOS



VACRON MOTO for android

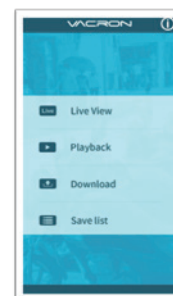

機車用監控系統

簡易操作手冊

2CH DVR主機 / HD 攝影機



※記憶卡並不隨機提供，請另外購買。

2CH DVR主機



多功能顯示器(選配)



HD 攝影機



產品外觀

■DVR主機

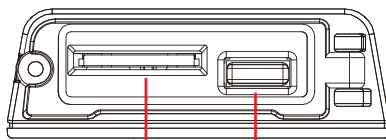

SD卡插槽
WiFi Dongle 插槽

■多功能顯示器(選配)

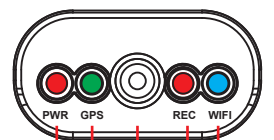

電源指示燈
GPS指示燈
REC 錄影指示燈
WIFI指示燈
麥克風接收器

線材說明



■ DVR車機線材

- (1)攝影機連接座 1CH
 - (2)攝影機連接座 2CH
 - (3)多功能顯示器連接座
 - (4)電源線連接座
- 備註：本機使用需搭配專屬行車攝影鏡頭



■ 電源線線材

- (a) 火線(紅色): 連接至電源正極。
- (b) 地線(黑色): 連接至電源負極。

產品配件

- 標配:
 1. DVR主機
 2. HD攝影機*2
 3. WiFi dongle
 4. 攝影機延長線2.5米*2
 5. 電源線
- 選配:
 1. 多功能顯示器
 2. 8/16/32G Class10 以上 SD 卡

H12AE0B04

安裝示意圖

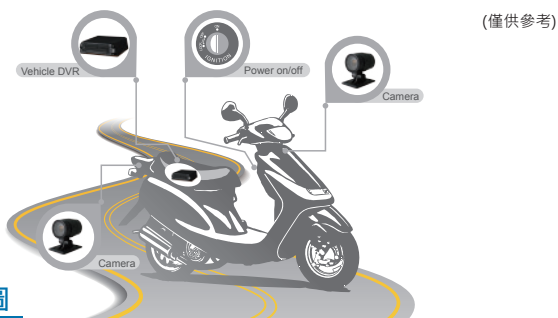

配線示意圖

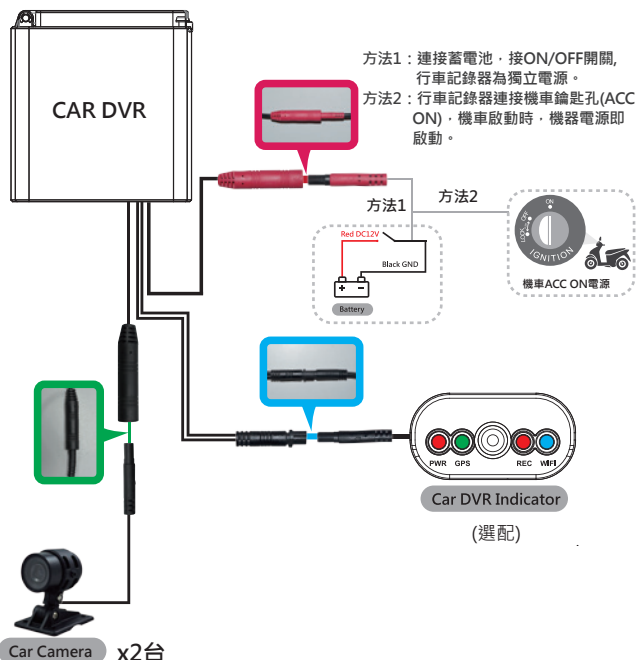

錄影及停止錄影

■ 開機錄影

電源啟動，並等待約 30 秒後，即開機完成。記錄器開機過程中，PWR 紅燈恆亮。當 REC 紅燈會呈現閃爍狀態，即表示開始錄影。

■ 關機/停止錄影

電源關閉後會延遲約 3 秒鐘才停止錄影，此時系統將緩衝區回寫至 SD 卡，待指示燈 熄滅後，即可取下記憶卡讀取所攝錄之檔案。

Viewer 介面

注意事項:

- (a) 要執行此軟體須安裝 DirectX 9.0 以上。
- (b) 支援作業系統：WINDOWS 7、8、10，不支援MAC OS
- (c) 建議的硬體需求：i3以上等級 2.7GHZ，RAM:4G以上、有獨立顯示卡更佳



馥鴻摩托APP

馥鴻摩托 IOS版

馥鴻摩托 ANDROID版

