

Full HD Car Camcorder

User Manual



- W/O GPS
- WITH GPS

2016 JAN V2.0

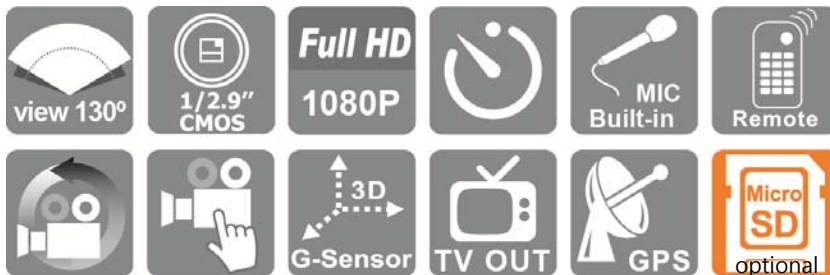

Safety Precautions

Please Take and review some testing videos initially to make sure the images were recorded correctly.

Please note that manufacturer, its subsidiaries and affiliates, or its distributors are not liable for consequential damages arising from any malfunction of main device accessory, including malfunction memory card that results in the failure of recording video or recorded video ca not be read.

Before using the product, please ensure that you read the safety precautions described below. Always ensure that the product is used correctly.

- Please keep this device away from a children or an infant.
- Use only recommended power sources.
- Do not apply multi cigarette lighter adapters-Applying such devices will cause unstable power input. As a result, the vehicle video recorder will shut down or cannot record video due to lost power.
- Please always make sure all power connectors are fully secured.
- Do not attempt to disassemble, alter or apply heat to the product.
- Avoid dropping or subjecting the product to severe impacts.
- To avoid the risk of injury, do not touch the interior of the product if it has been dropped or otherwise damaged.

- Stop using the product immediately if it emits smoke, a strange smell, or otherwise behaves abnormally.
- Do not use organic solvents such as alcohol, benzene, or thinner to clean the product.
- Do not let the product come into contact with water (e.g. sea water) or other liquid.
- Do not allow liquids or foreign objects to enter the Vehicle Video Recorder.
- Do not allow dirt or metal objects (such as pins or keys) to contact the terminals or plug.
- Avoid using, placing or storing the product in a humid or dusty area.

Index

A. Feature Description	1
B. Specification	2
C. Accessories	3
D. Installation Instruction	4
E. Product Dimensions	6
F. SD Card	7
G. Remote Controller	9
H. Recording / Stop Recording	10
I. OSD Menu Function	11
J. Playback Video Files	13
K. VACRON Viewer	14

A. Feature Description

- Built-in megapixel Sony CMOS Sensor.
- Built-in supercapacitor offers extensional power supply and ensures video is well stored of critical moment and compact.
- 130°Wide angle 6G+IR glare-depressed lens.
- Built-in synchronous single-channel microphone.
- Recorded Video store in Micro SD card, Max 64GB).
- Auto loop recording when memory card is inserted and device is power on.
- Emergency recording button protect data in secured area from being overwritten.
- Build-in G-Sensor event recording.
- GPS and Image data are recorded and playable on client software. (Only available with GPS receiver)
- Support FULL HD record and TV-out to car entertainment cable.

B. Specification

Item	Description
Sensor	Sony 1/2.9" CMOS Sensor.
Resolution	NTSC 1920x1080 (2M) 30 fps.
	PAL 1920x1080 (2M) 25 fps.
View Angle	130° Wide-angle.
Power Supply	DC5V±5% / 1 Amp.
	Built-in 1.5F supercapacitor to backup power.
Operating Tmp.	-10°C ~ +60°C
Storage	Support 8gb class 10 micro sd card or above, up to 64GB.
Recording	Start recording automatically when power up.
	Prompt recording when power on Delay 3 seconds after power shutdown.
Recording Data	Date/Time/Video/Audio/G-Sensor/GPS data.
Storage Format	*.ts file is playable on most players, exclusive player available on VACRON website.
	Use remote control to playback.
Audio Input	Built-in microphone.
Time Setting	Built-in calendar clock to adjust the time.
	Time adjustment with synchronous GPS and time zone. (GPS model)
G-Sensor	Built-in 3D G-sensor.

- NOTE
1. Version updating is not going to inform, please check the on-going updating information
 2. SD Card. (optional)

C. Accessories

- 3.5M mini-USB power cable
- 5V cigarette power adapter
- Remote controller
- USB card reader
- Suction cup bracket
- Bracket holder
- Quick user manual
- 4 pins, 3.5 inch headphone jack to RCA output cable

D. Installation Instruction

1. To install the device on the windshield by” Sucker-type holder
” or “Stick-Holder” Type

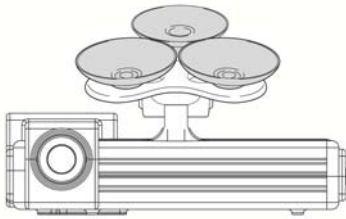

Sucker-type holder

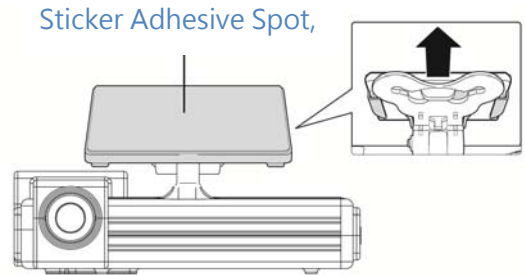

Stick-Holder

2. Install the device on the windshield in the best position

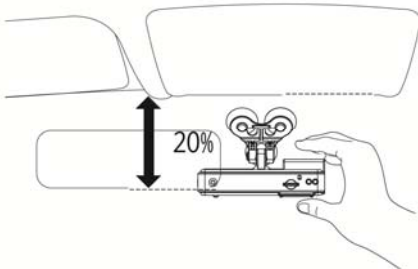

3. To adjust the recording angle properly

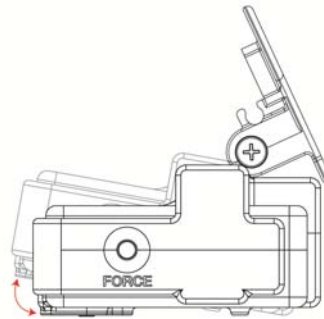

4. Plug in DC5V Power Supply

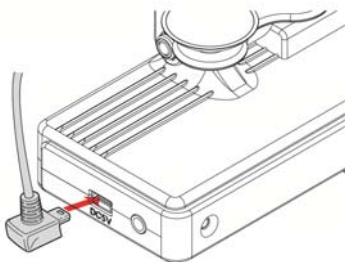

5. Plug in the Cigarette Lighter Adaptor

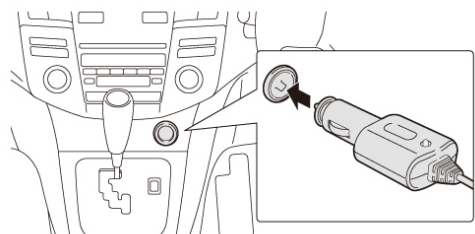

6. VVR installation instruction

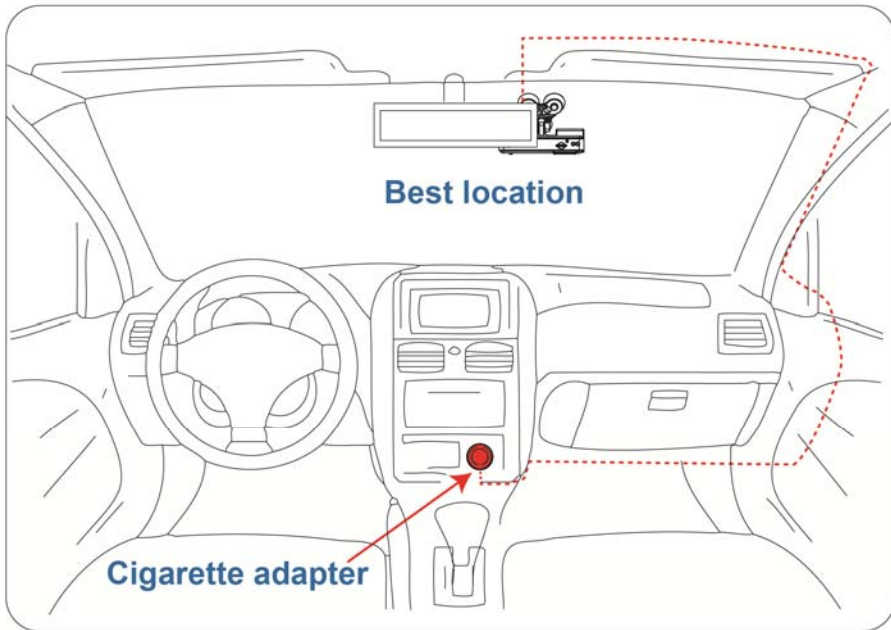

Caution

- (1). This device should be installed in the area where the Windshield will be able to be cleaned by windshield wiper.
- (2). Formatting SD card on the PC before beginning to use.
- (3). Set time zone and timing on OSD. Star the device immediately after you set time zone to make sure the video files will tally with normal time.
- (4). Setting NTSC or PAL through OSD.

E. Product Dimensions

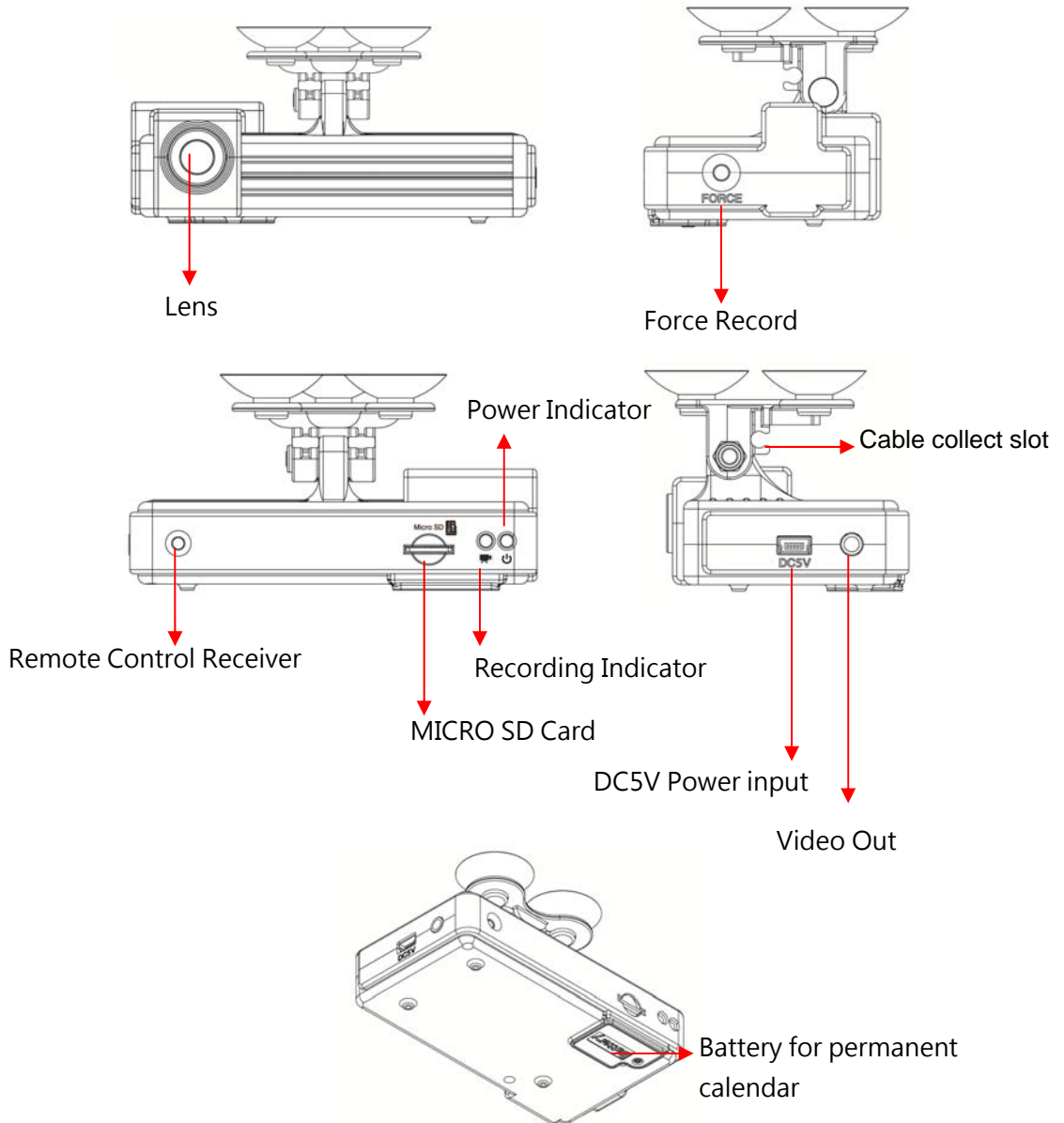

F. SD Card

1. "Format" Micro SD card

While applying a brand new Micro SD card, or use a Micro SD card that was take out from other devices, a formatting procedure is required.



- (1). "Format" will clean all the data saved on Micro SD card, Please back up the data before proceed " Format" .
- (2). Before "Format " Micro SD memory card, please ensure that Micro SD memory card is unlocked.
- (3). If the card is unlocked but still cannot be formatted, this might be caused by Windows security restrictions. Please run the program as Administrator to prevent from this problem.

2. SD Card Installation

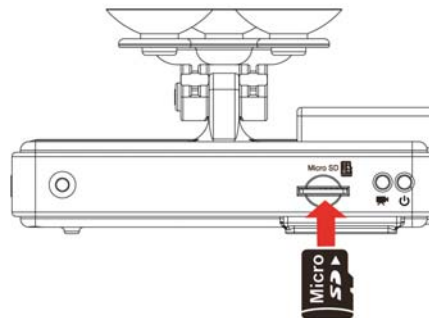

Remark: Memory Card is optional



Caution

- (1). Recommend memory card class 10 or above 8GB Micro SD Card, max to 64GB.
- (2). Since memory cards have the writing endurance situation, we recommend to inspect the memory card and use pc for playback regularly, to ensure that the memory card can read and write
- (3). Hot swap is not supported. Please power off device before remove memory card. Removing Memory Card while recording may lose or damage recorded data.

3. Record Time Estimation

The chart below is for reference only. The length of time recorded can be varied due to variation in image size may be different.

Capacity	8GB	16GB	32GB
Video Quality			
High	90 Min	180 Min	360 Min

G. Remote Controller

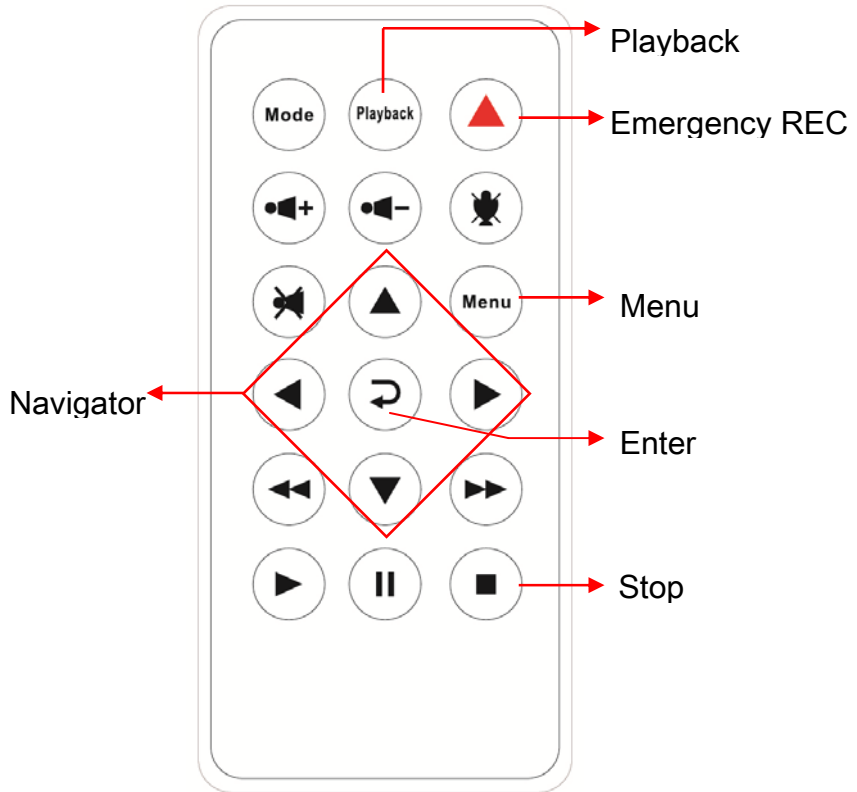

<div data-bbox="333 1264 491 1424" data-label="Image"> </div> <p data-bbox="243 1477 585 1553">How to check if the remote controller is workable?</p>	<ul style="list-style-type: none"> √ Check the mercury cell is installed in correct direction. (Check the pole) √ Check if the cell power is exhaust. √ Check if the sensor is covered. √ Check if it nears by Fluorescent Lamp.
---	--

H. Recording / Stop Recording

1. Power On/Recording

When car power on, the device start up automatically. Please wait for 15 Sec. to start recording.

2. Power Off/Stop recording

When the car power off, the device will stop to record video and sound. You can take off the memory card and insert to computer to view the video.

3. Indication

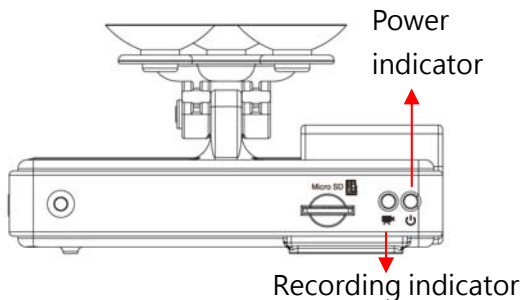

- (1). Recording indicator: Red light Blinking when recording. (Emergency recording blinking fast)
- (2). Power indicator: Continuous green light means GPS located successfully.







Caution

- (1). The display of booting screen and live view are subject to change without notice for software upgrade or re-version.
- (2). Force recording button has highest priority. Push Force recording button will pop up recording window and activate force recording immediately.
- (3). CR1220 Battery for calendar can be replaced by users.

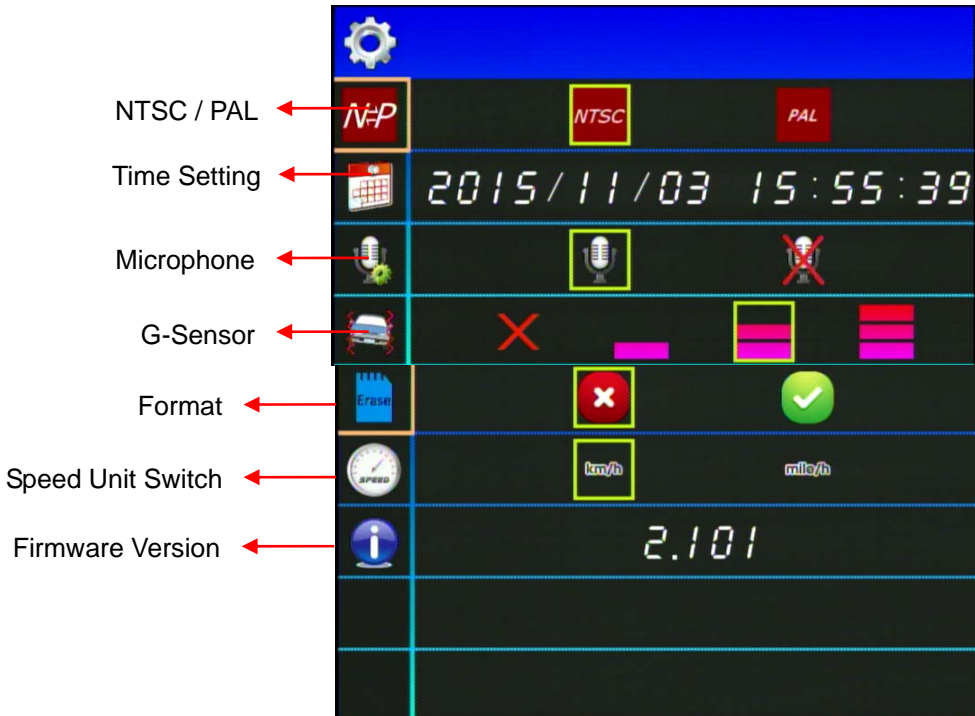

I. OSD Menu Function

In Live view screen press [Menu] will popup OSD operation menu as follows:



1. Video Type :Click  to choose NTSC /PAL.
2. Time setting: Click  to adjust clock.
3. Microphone: Click  to setup microphone on / off.
4. G-Sensor: Click  to set the sensitivity of G-sensor. The higher the sensitivity on behalf of gravity (G) the more

sensitive the sensor, the more likely trigger mandatory photography; When emergency record is triggered, it will keep emergency recording and keep the files without being event video overwritten.

5. Format: Click  to format Micro SD card.
6. Speed Unit Switch: Click  to switch [km/h] / [mile/h]. (for GPS function).
7. Firmware Version:  show firmware version.

J. Playback Video Files

Playback the video files on PC via the storage card from the vehicle recorder.

Suggest use exclusive player program or via video play software to open .TS files. Such as KM 、Baofeng 、Windows build in Media player... etc. Please install decoder if can't play the files.

* Please backup important files just in case of overwritten.

* Please use exclusive player to read GPS data.

 2014-05-06-13-59-14.ts	2014/5/6 上午 06:02	KMP -Video File	210,081 KB
 2014-05-06-14-02-14.ts	2014/5/6 上午 06:05	KMP -Video File	209,764 KB
 2014-05-06-14-05-14.ts	2014/5/6 上午 06:08	KMP -Video File	209,572 KB
 2014-05-06-14-08-14.ts	2014/5/6 上午 06:11	KMP -Video File	209,524 KB
 2014-05-06-14-11-14.ts	2014/5/6 上午 06:14	KMP -Video File	209,234 KB
 2014-05-06-14-14-14.ts	2014/5/6 上午 06:17	KMP -Video File	210,218 KB
 2014-05-06-14-17-14.ts	2014/5/6 上午 06:20	KMP -Video File	209,701 KB
 2014-05-06-14-20-14.ts	2014/5/6 上午 06:23	KMP -Video File	209,928 KB

K. VACRON Viewer

★ Reminder- DirectX 9.0 is required.



Allow to move the user interface to left or right.



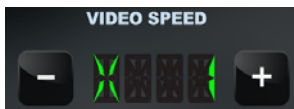



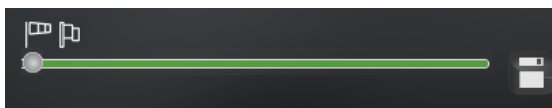

1. Playback Speed: Fast Forward 2X, 4X, 8X; Slow Forward 1/2X, 1/4X, 1/8X



2. Scroll Bar: playback display can be scrolled to wanted position. Set the start and end point to identify the range, right click to backup the video files.









3. Control Panel

	Pause
	Reverse
	Play
	Stop
	Previous File
	Previous Frame
	Next Frame
	Next File

4. Volume control: Click + , - to adjust volume.



5. Float Interface

	Click into video list to play and backup
	Capture playing screen and recording data
	Display version information and set up version language
	Play list, time list
	G-sensor
	Show the icon when receiving GPS data, watch the driving track on map



For More Information
Please check VACRON Website
<http://www.vacron.com>

Made in Taiwan
