

HD Vehicle Video Recorder

User Manual

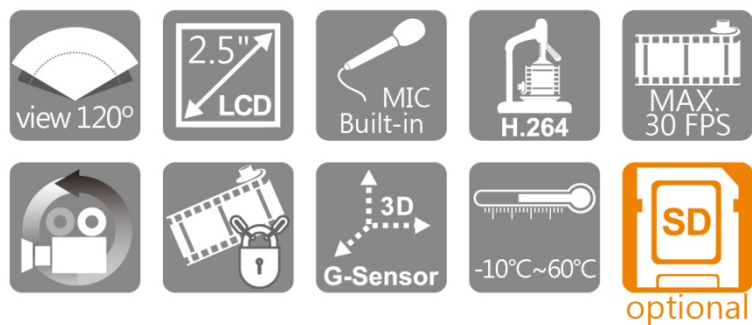

2016. JAN V2.0



Safety Precautions

Please Take and review some testing videos initially to make sure the images were recorded correctly.

Please note that manufacturer, its subsidiaries and affiliates, and its distributors are not liable for consequential damages arising from any malfunction of main device accessory, including memory device that results in the failure of an image to be recorded or to be recorded in a way that is machine readable.

Before using the product, please ensure that you read the safety precautions described below. Always ensure that the product is used correctly.

- Use only recommended power sources.
- Do not attempt to disassemble, alter or apply heat to the product.
- DO not apply multi cigarette lighter adapters-Applying such devices will cause unstable power input to damage the vehicle video recorder.
- Please always make sure all power connectors are fully secured.
- Avoid dropping or subjecting the product to severe impacts.
- To avoid the risk of injury, do not touch the interior of the product if it has been dropped or otherwise damaged.
- Stop using the product immediately if it emits smoke, a strange smell, or otherwise behaves abnormally.
- Do not use organic solvents such as alcohol, benzene, or thinner to clean the product.
- Do not let the product come into contact with water (e.g. sea water) or other liquids.
- Do not allow liquids or foreign objects to enter the VVR.

- Do not place the VVR near or in direct flame.
- Do not handle the power cord with wet hands.
- Do not use the equipment in a manner that exceeds the rated capacity of the electrical outlet or wiring accessories.
- Do not use if the power cord or plug are damaged, or not fully plugged into the outlet.
- Do not allow dirt or metal objects (such as pins or keys) to contact the terminals or plug.
- Avoid using, placing or storing the product in the humid or dusty areas.

Index

A. ACCESSORIES.....	1
B. FEATURE DESCRIPTION	2
C. SPECIFICATIONS.....	3
D. INSTALLATION	5
E. PRODUCT FUNCTION INTRODUCTION.....	7
F. SD CARD INSTALLATION	9
G. RECORD AND STOP	10
H. REMOTE CONTROL.....	11
I. OSD MENU FUNCTION.....	12
J. PLAYBACK.....	13
K. VACRON VIEWER	14
L. RECORD TIME ESTIMATION.....	18
M. CRITERIA OF TFT LCD INSPECTION	19
APPENDIX – EXCEPTION CLAUSE.....	20

A. ACCESSORIES

Please review the contents prior to use. Please contact your local dealer if something not found in the box.

※ Storage card is not included in the box as free provision.

■ Standard

Cigar Lighter Adapter

Bracket holder

Suction cup bracket

Quick User Guide

IR Remote Controller

■ Optional

8G / 16G / 32G / 64G Class10 or above SDHC Card

SD Card USB Reader

B. FEATURE DESCRIPTION

- Built-in super capacitor offers extensional power supply and ensures video is well stored of critical moment and compact.
- Wide angle glare-depressed lens .
- Low light high sensitive sensor equipped.
- High environmental tolerant casing, high temperature resistant casing which doesn' t release toxic gas and deformation.
- HD Recording Resolution.
- SDHC storage card max. to 64GB.
- Auto loop recording when memory card is inserted and device is power on.
- Emergency recording button protect data in secured area from being overwritten.
- Build-in G-Sensor event recording. Zoom IN/OUT by mouse wheel on Carbox player.

C. SPECIFICATIONS

Item	Description
Sensor	CMOS Sensor
Resolution	NTSC 1280x720(720p), 30fps ° PAL 1280x720(720p), 25fps °
Power Supply	DC5V±5% / 1 Amp. Build-in 1.5F super-capacitor.
Operating Tmp.	-10°C~ +60°C
Storage	SDHC Card Recommended Class 10or above 8GB at least, max to 64GB.
Recording	Start recording automatically when power up, extensional 3 seconds recording after power off.
Recording Data	Date/Time/Video/Audio/G-Sensor
Playback	TS files playback on normal player, or download player from Vacron website, also playback by using remote control on the machine.
Audio Input	Built-in microphone
Time setting	Use remote control to set up time in OSD interface.
G-Sensor	Built-in 3D G-Sensor

※ Storage card is not included as free provision.

※ Specifications shall be changed subject to necessary update.

Notification:

1. Startup Menu and OSD (on screen display) might be varied with firmware update.
2. Please refer to the SD card usage and life limit, and check video recording periodically with Carbox player on PC to ensure normal recording.
3. Please replace build-in battery CR1220 for clock memory when time is not calibrated.

D. INSTALLATION

1. Select 「Suction-cups」 or 「Stick-Holder」 to install on windshield.

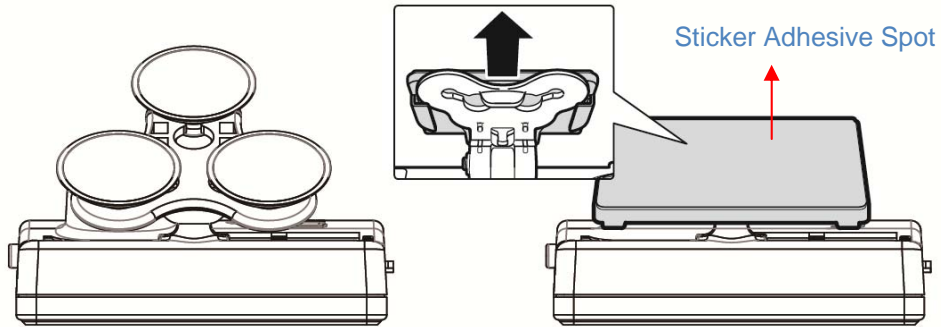

2. The best position to install the device on the windshield

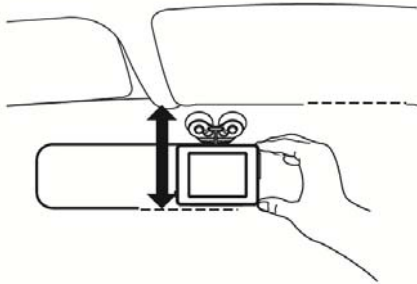

3. Adjust the view angle properly

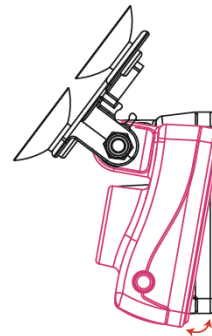

4. Plug in DC5V Power Supply

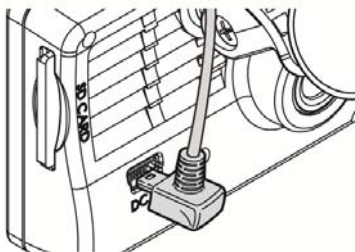

5. Plug in the Cigarette Charger

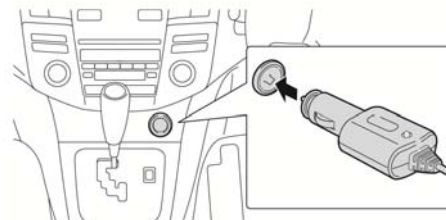

6. VVR Installation

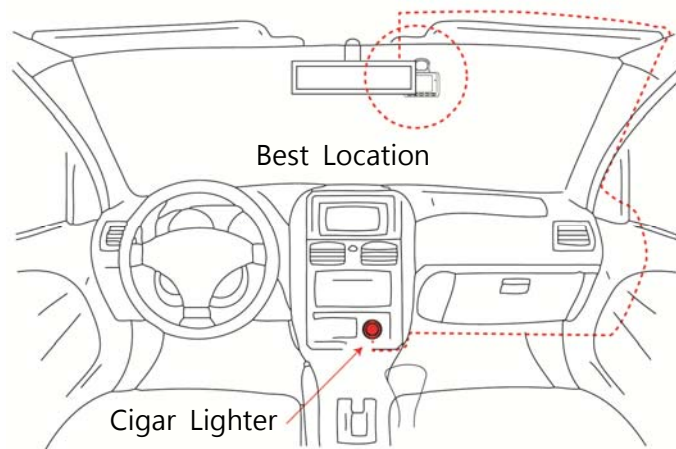

Notice

- (a) This device should be installed on the windshield of clean and dry.
- (b) The best location must be in the range of the moving wiper.
- (c) Format the memory card in the DVR prior the very first recording.
- (d) Set time zone and timing on OSD.

E. PRODUCT FUNCTION INTRODUCTION

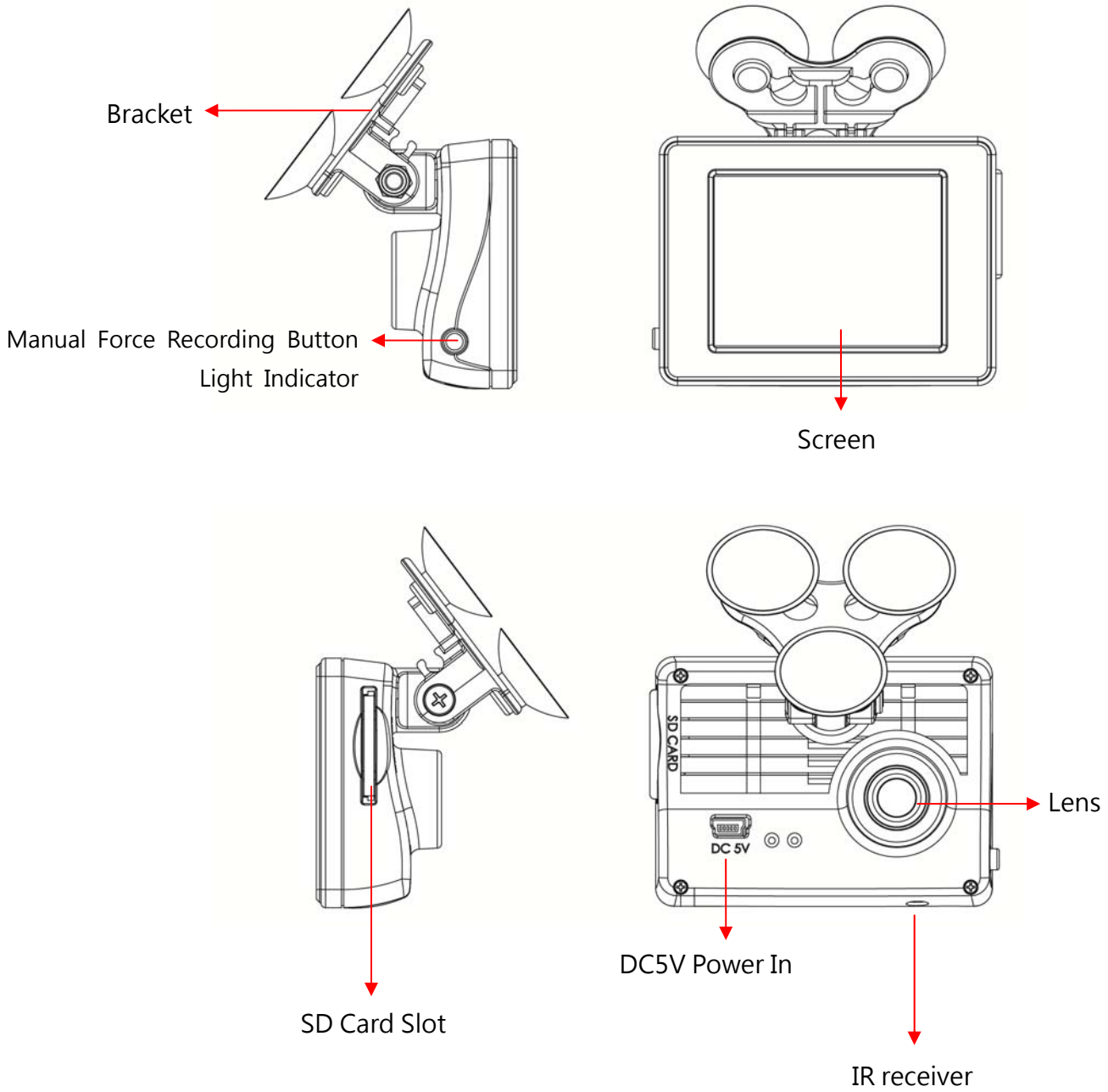

Size of VVR

Unit : mm

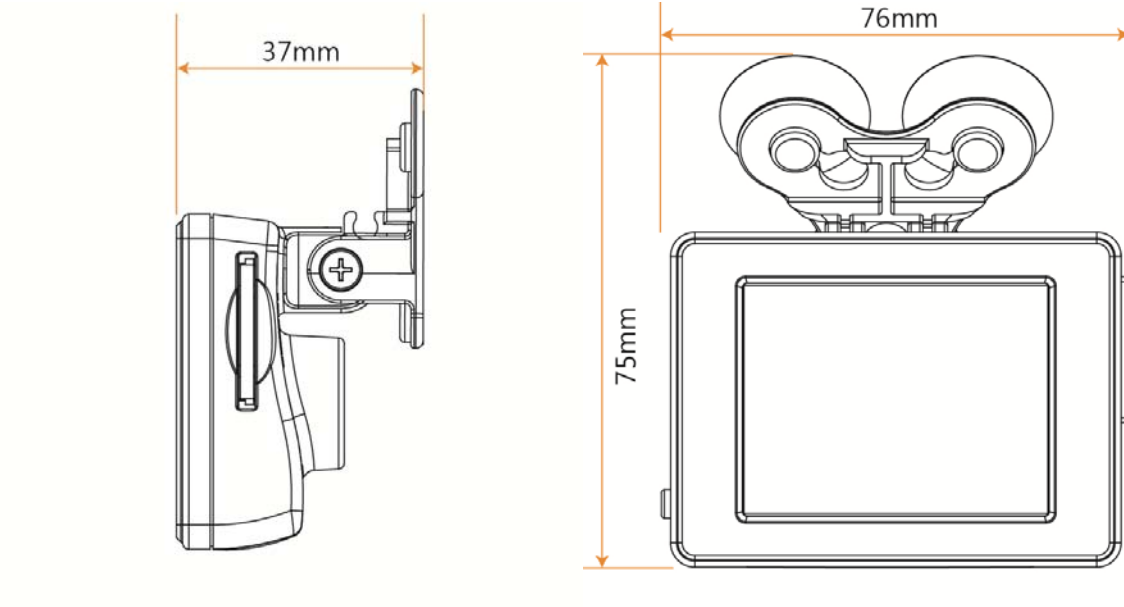

F. SD CARD INSTALLATION

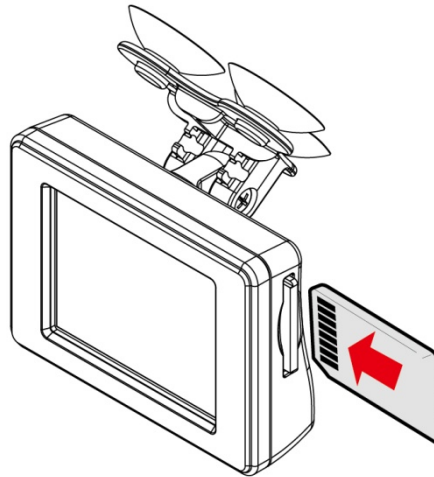

(1). Please read other pages for detailed information of SD card format.

Reminder – SD card is not free provision from manufacturer.



Warning

- (1). Recommended Class 10 or above 8GB at least, maximum support to 64GB
- (2). If the memory card is not formatted by the player, the device will automatically erase all the data.
- (3). Please DO NOT use micro SD card adaptor. The adaptor could cause recording stability.
- (4). Memory card has its limit on written times. It is suggested to check SD card files with PC player Carbox player periodically.

G. RECORD AND STOP

1. Reboot / Record

Reboot the DVR system ready in 20 seconds. DVR starts recording.

2. Power Off / Stop

It stops recording once power is off, build-in capacitor offer 3 seconds extra power to make sure file is well stored. User can remove the memory card after the indication light is off.

3. Light indicator

Red indicator: Flicker means on recording (Force recording with fast flicker.

4. Force Recording

Force recording with enforcement, any statues trigged force recording will back to record display and start to force recording.



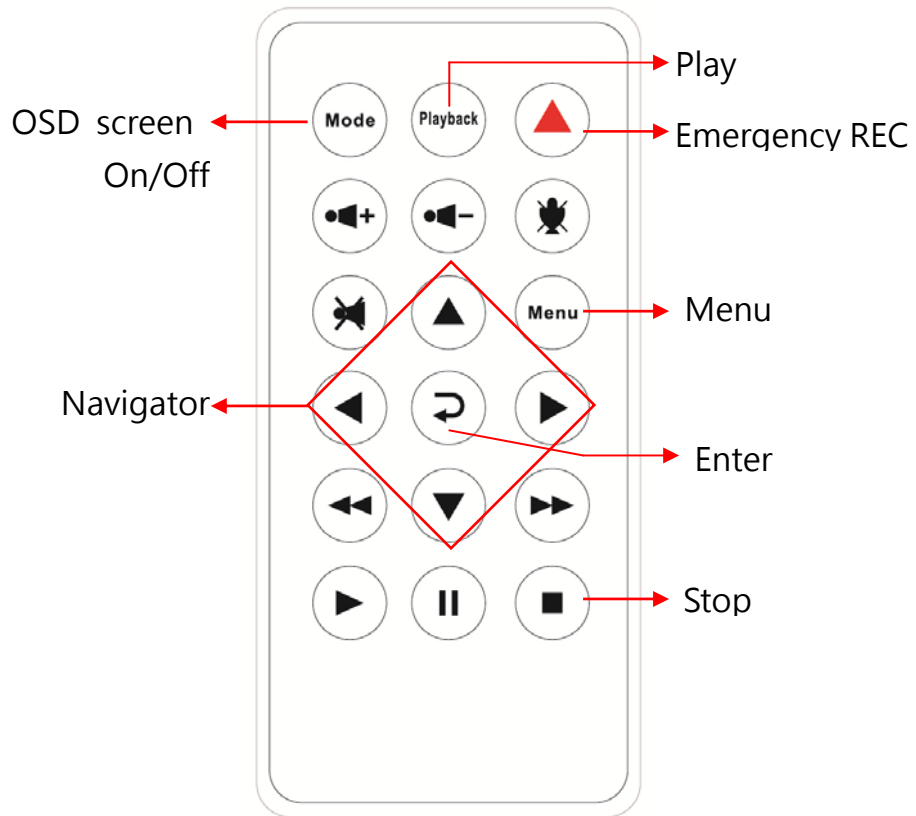



H. REMOTE CONTROL

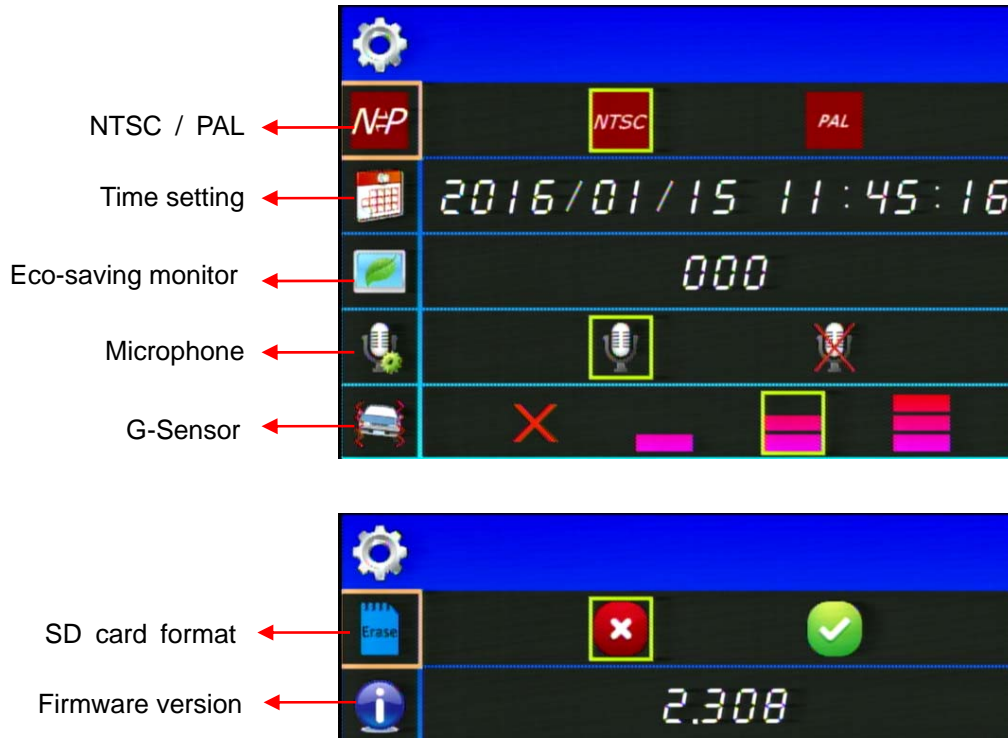

I. OSD MENU FUNCTION

Select Menu enter OSD as below





1. Video standard: click  to set NTSC or PAL.
2. Time setting: click  to set calendar.
3. Monitor setting: click  to set Eco-saving mode.
4. Microphone: click  to set microphone on or off.
5. G-sensor: click  to adjust the sensitivity of G-sensor.
6. SD card format: click  to format SD card.
7. Version: click  to show current firmware version information.

J. PLAYBACK

Click the playback function to enter playback menu, and choose the recorded video fragment.



1.  : Manual/Emergency Recording.
2.  : G-Sensor Recording.

K. VACRON VIEWER

★ Reminder- DirectX 9.0 is required.



Allow to move the user interface to left or right.



1. Playback Speed: Fast Forward 2X, 4X, 8X; Slow Forward 1/2X, 1/4X, 1/8X

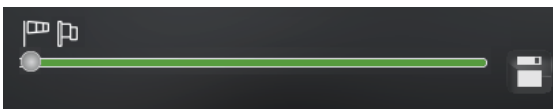

2. Scroll Bar: playback display can be scrolled to wanted position. Set the start and end point to identify the range, right click to backup the video files.



3. Control Panel

	Pause
	Reverse
	Play
	Stop
	Previous File
	Previous Frame
	Next Frame
	Next File

4. Volume control: Click + \ - to adjust volume.



5. File backup: click  to choose file save directory.

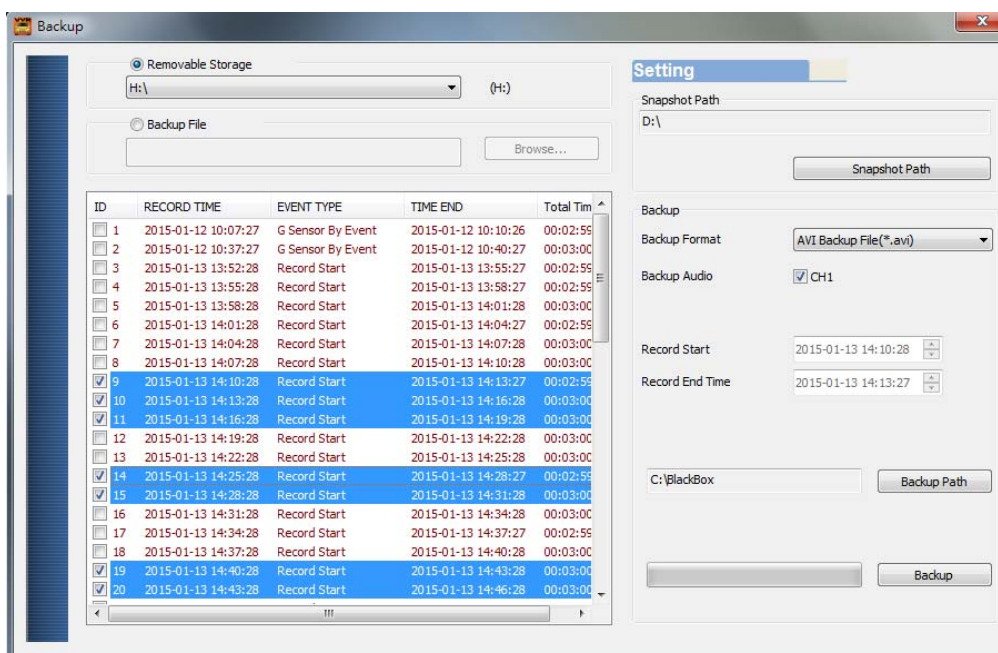

6. Snap Shot: to capture the picture during playback, and click  to save the file to directory (default directory: /Snapshot, the saving directory can be changed. The file format is “.bmp”)

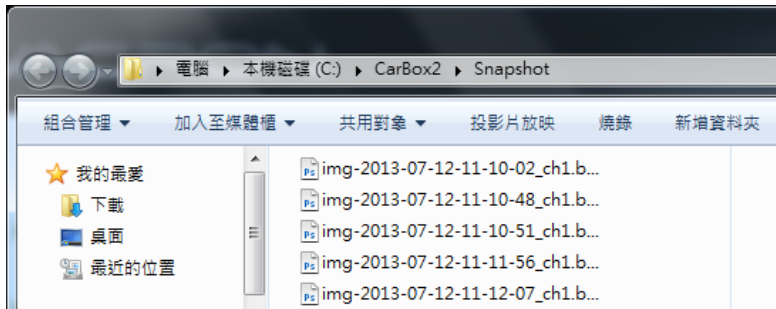

7. Current Version: click  to view current version and setting language.

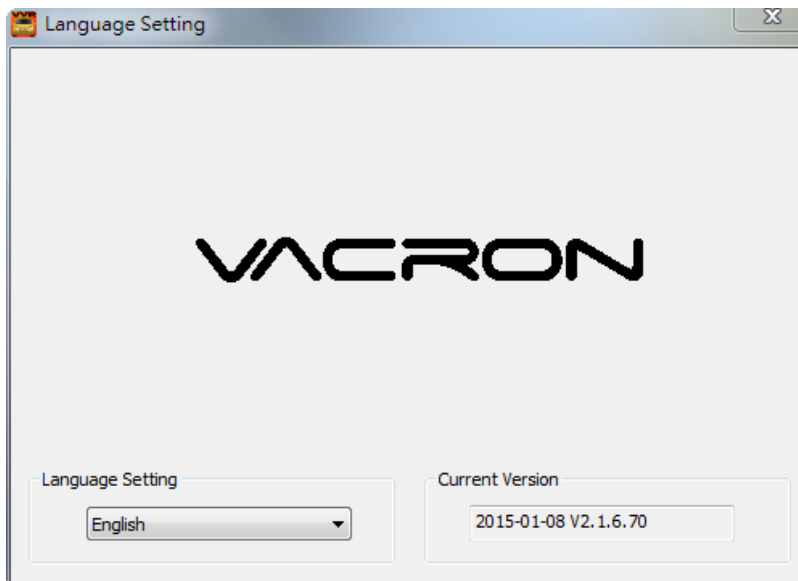

8. Playback List:  to access video recording and jump to required segment by scrolling time bar.

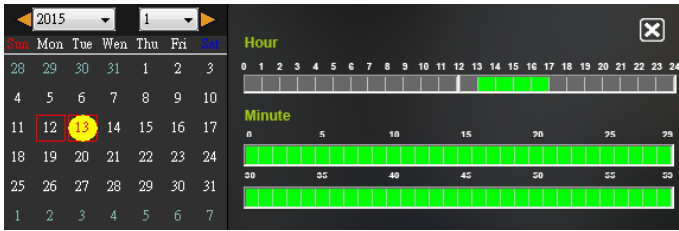

9. G-SENSOR 

G-Sensor will detect the impacts from the car, and record 1-3 minutes video automatically. This footage saves to the separate area to avoid file from being overwritten.

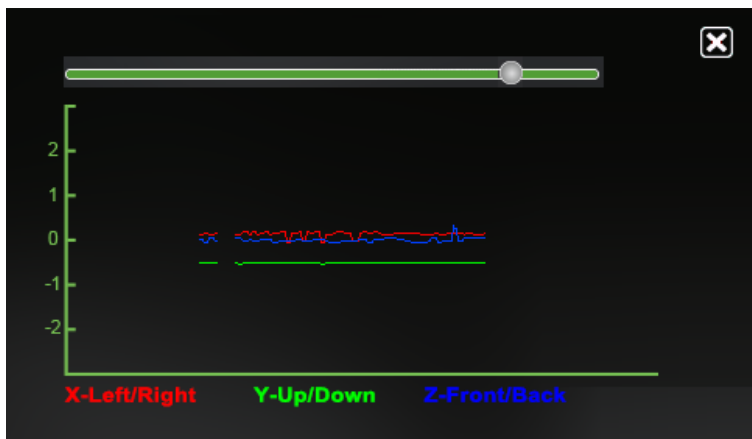

(1) **X** : Detect vehicle horizontal change.

(2) **Y** : Detect vehicle vertical change.

(3) **Z** : Detect vehicle front/back change.

L. RECORD TIME ESTIMATION

The chart below is for reference only. The length of recording time can be varied due to variation in image size and video quality.

Capacity \ Quality	8GB	16GB	32GB
High	3H	6H	12H

M. CRITERIA OF TFT LCD INSPECTION

Q: What is bright spot? What is dark spot?

A: • Bright Spot: At dark background, we found the abnormal bright spots, we called those spot are "Bright Spot"

- Dark Spot: At multiple color background (excluded dark background), we found the abnormal dark spot, those spots are "Dark Spots"

Q:Criteria of bright spot

- No bright spot in zone A and only one dark spot here.
- 2 bright spots is OK in zone B same standard to dark spot.
- Totally 3 Bright spot plus dark spot is OK in zone A+B.

1/4	1/2	1/4	
B	B	B	1/4
B	A	B	1/2
B	B	B	1/4

Zone A and Zone B



Precautions

- 30 days return policy against Criteria of TFT LCD Inspection.
- You can get the replacement from your local dealer within 30 days from the receipt date.
- Only 30 days validity and RMA not included.
- Light emitting components are weaker time by time. Changes on brightness, color and ghost image are in tolerance range.

APPENDIX – EXCEPTION CLAUSE

Fuho Technology Co., Ltd. states exception clause to reserve the rights of the exclusive warranty and product liability hereafter.

1. Users do not follow the proper installation stated in user manual.
2. Not authorized repair agent gets the DVR damaged.
3. Damaged out of abnormal operation.
4. Damaged out of abnormal surroundings.
5. Damaged out of natural disaster or force majeure.
6. Damaged out of delivery by unauthorized dealers.
7. Damaged out of illegal software or components.
8. Invalid serial number or no number.
9. Noise from other products.
10. Damaged out of strong impact.

Applicable law and jurisdiction court

Explanation, application and other not stated should be regulated by the law of Republic of China. The jurisdiction of the first trial is the district court of Chang Hua, Taiwan.



For more information
Please visit VACRON website
<http://vvr.vacron.com>

Made in Taiwan
